

Overview of Key AnyLogic Infrastructure, Modeling Types and Interface

Nathaniel Osgood

CMPT 858

January 13, 2011

Announcements

- Links to 3 installers distributed
- Department machines requisitioned
- Tutorial time feedback sought

Project Ideas

- HPV/Cervical cancer
 - Smoking/Age/Ethnicity/Vaccination
 - Adapting existing aggregate model
 - Contact: Karen Yee (returns Monday)
- eLearning system
 - Facilitating learning by tapping into social networks
- MRSA (nosocomial – institutional spread)
 - Tie-in with institutional flow models
- Gonorrhea
 - Mutation & drug resistance
 - Sexual networks
- Chronic Wasting Disease
 - Movement of animals over landscape
 - Seasonal changes in behaviour
 - Contact: Cheryl Waldner
- TB
 - Contact: NDO & Assaad Al-Azem
 - Work with TB Control

Project Ideas

- Gestational & Type 2 Diabetes
 - Intergenerational effects of diabetes in the mother
- H1N1 Spread
 - Network micro-data
 - Aggregate data?
 - Contact: Cheryl Waldner & Simon Kapaj
- Lifecourse weight trajectories
 - 50 year longitudinal data (National Childhood Development Survey)
- Physiological model of weight & body composition
 - Interaction with
 - Food intake
 - Physical activity

AnyLogic basics

- Multi-platform
- Declarative graphical languages
- Basic language: Java
- Rich library of built-in objects
- Continuous or discrete time/space
- Modeling approaches supported
 - System Dynamics
 - Agent-based
 - Regular & irregular spatial embedding, network embedding
 - Discrete event

System Dynamics

- Feedback-focus
- Traditional graphical depiction
 - Stocks (state of system)
 - Flows (rates of change to the
 - Continuous variation in state
- Stocks are initialized, are then change according to flows
- Values of flows are determined by stocks & any other variables

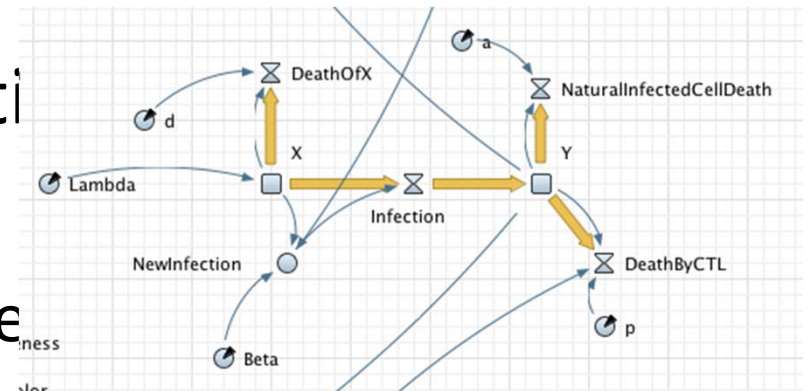



Hands on Model Use Ahead



Load model: SIR Agent Based.alp

Agent-Based Approaches

- Agent (actor) focused
- Traditional graphical depiction:
State transition diagram
 - States
 - Transitions
 - Discrete variation in state
- Regular or irregular topologies connect between agents
 - Messages sent via connections

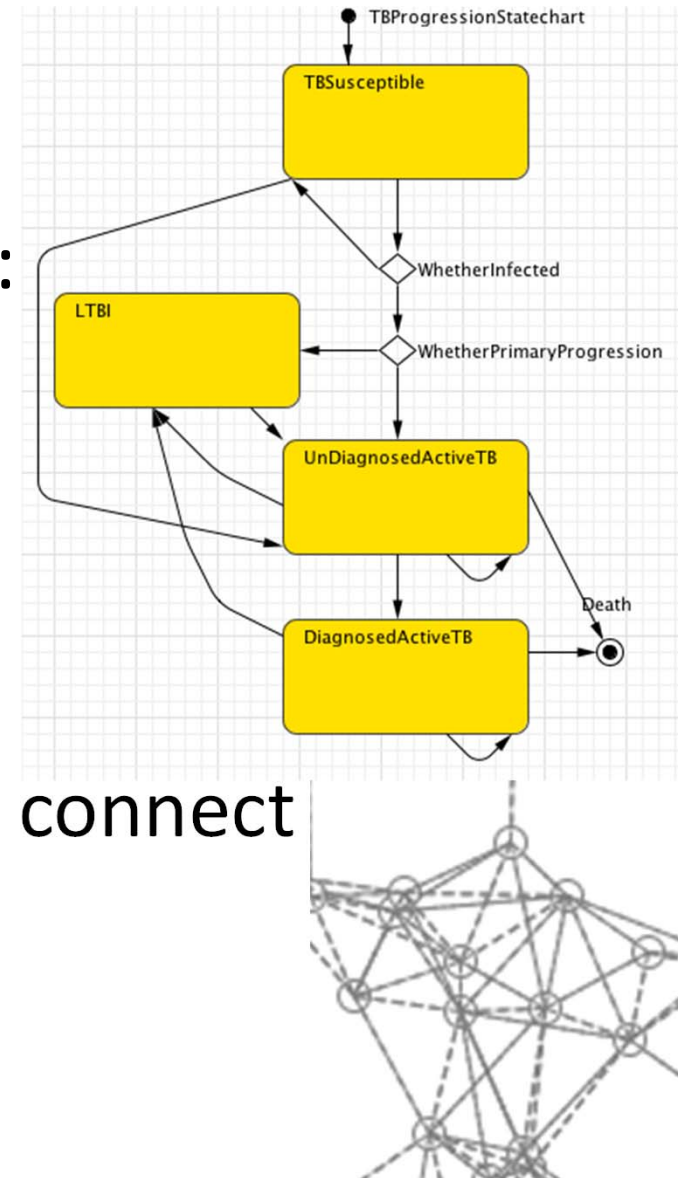



Hands on Model Use Ahead



Load model:
Emergency Department Tulsa.alp

Discrete Event Modeling

- Resource-based modeling
 - Queues
 - Processes
 - Flow charts
 - Capacitated resource pools
 - Send to
 - Attachment/detachment

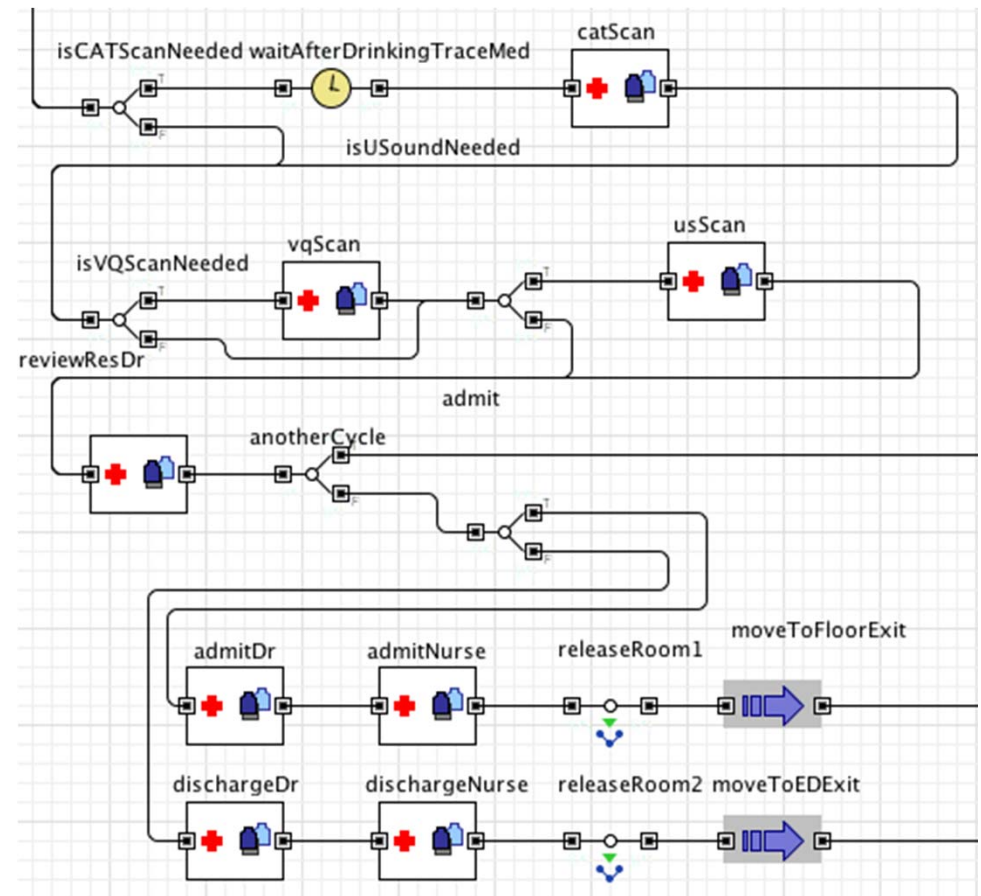

“Network Modeling” Irregular Spatial Embedding



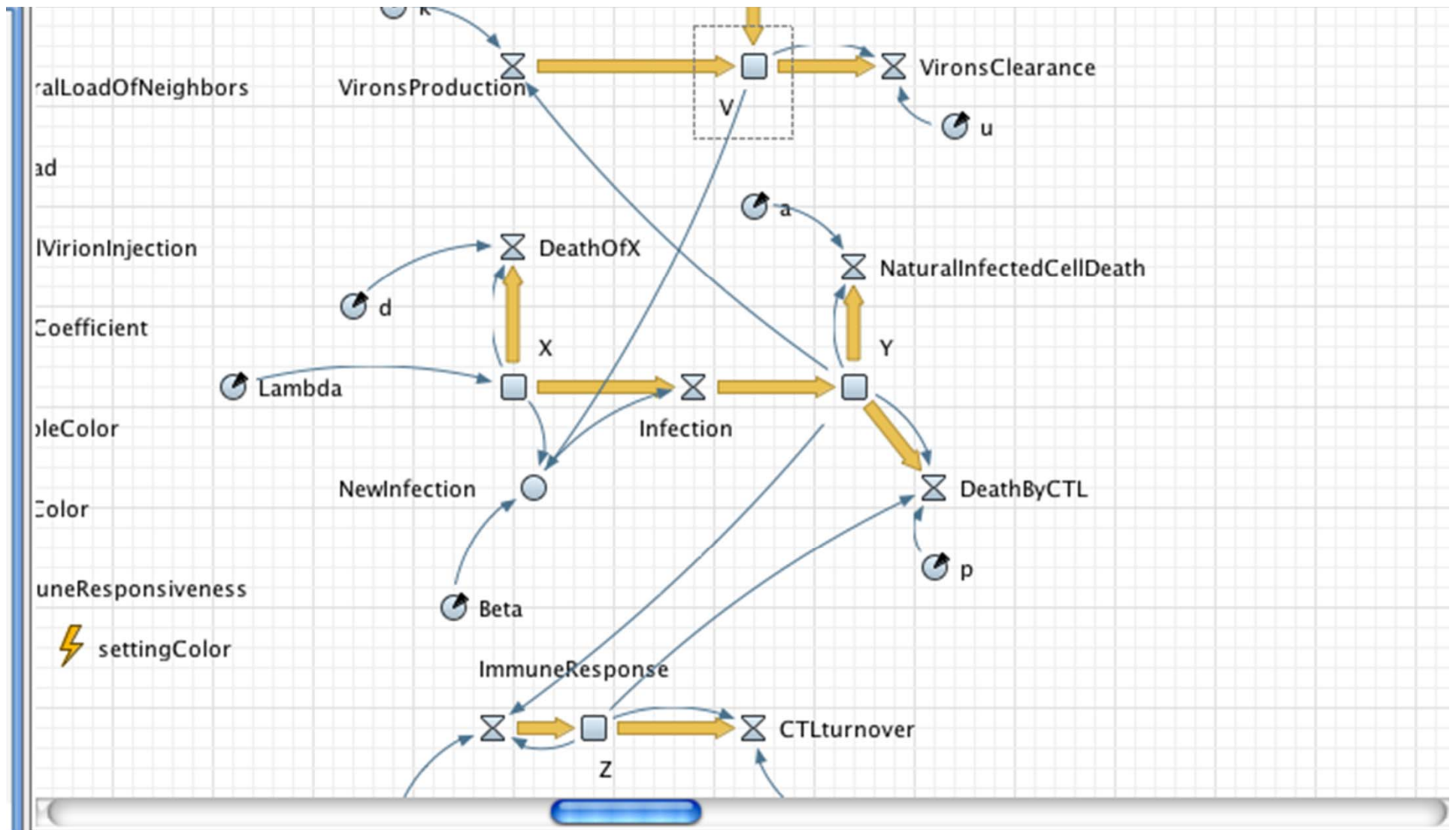

Properties Console

Person - Active Object Class

General

Advanced

Agent

Name:

Ignore

Network Embedded Individuals

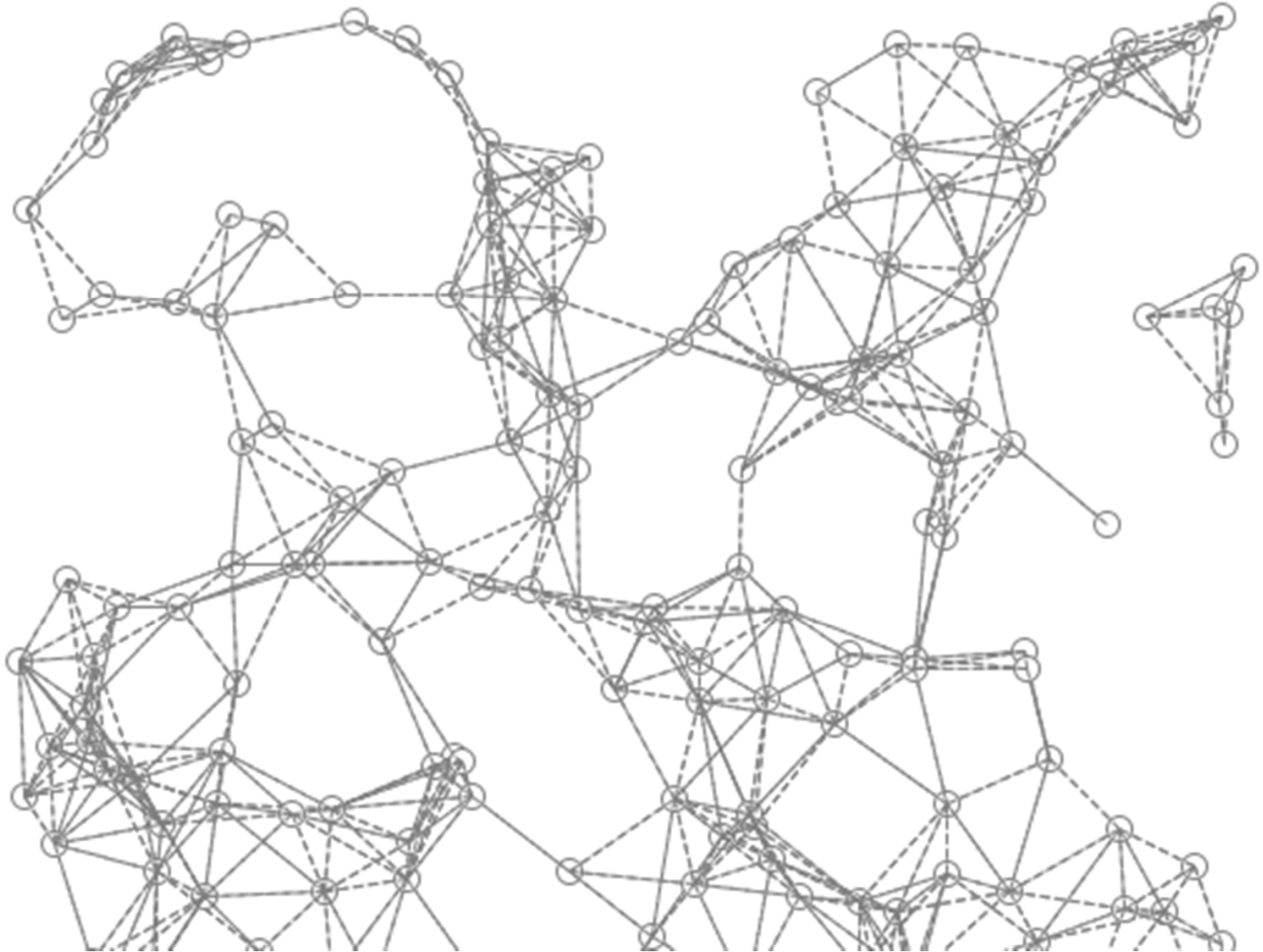

Regular Spatial Embedding

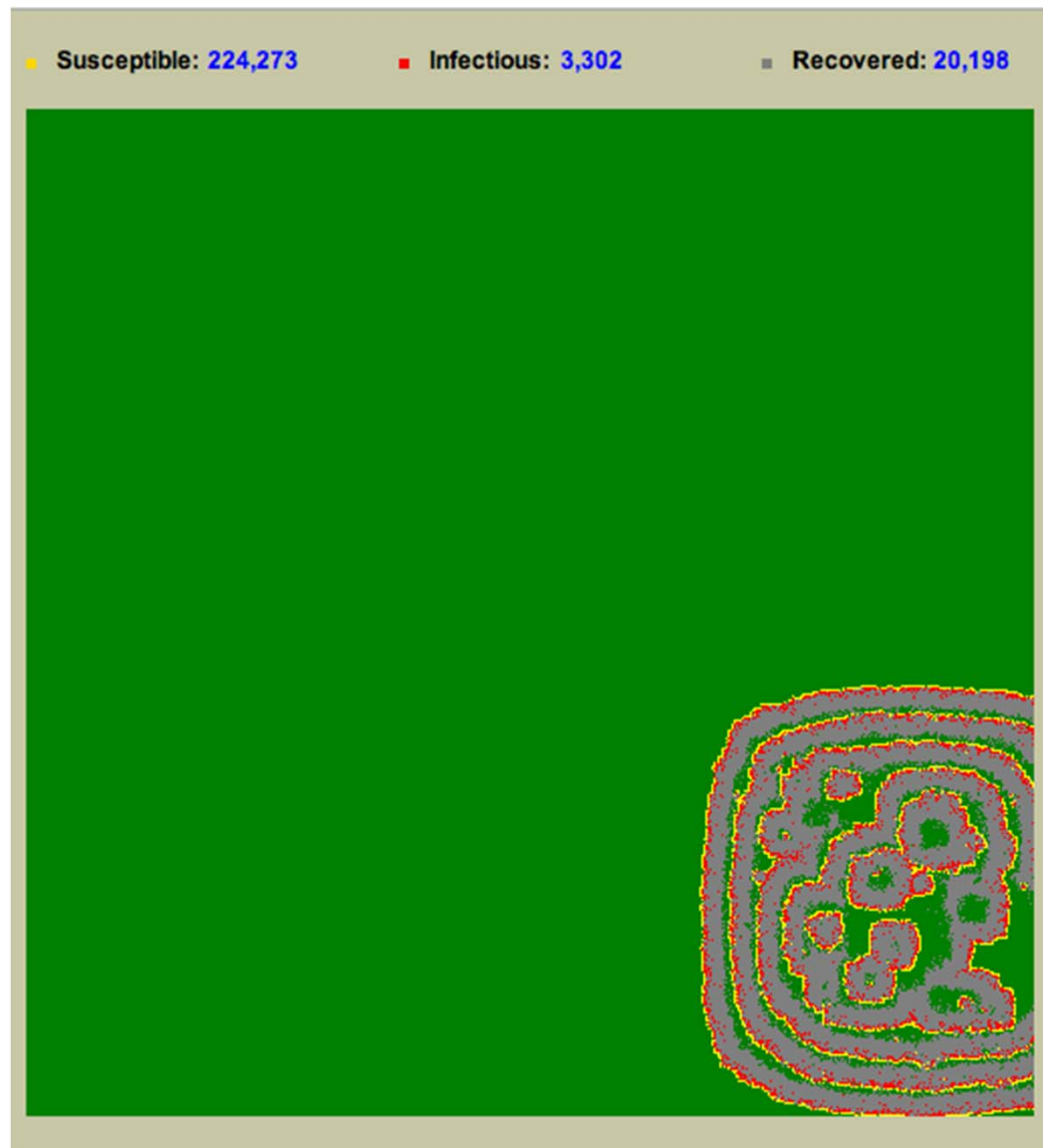

Hybrid Models

- Much of the power of AnyLogic lies in its ability to integrate multiple types of modeling in a single model
- Attractive schemes
 - Agent-based using system dynamics for continuous agent state (c.f. age)
 - System dynamics using agent-based to determine flows
 - Agent-based using system dynamics for global dynamics
 - Agents entering into process-based health services

Example Hybrid Model

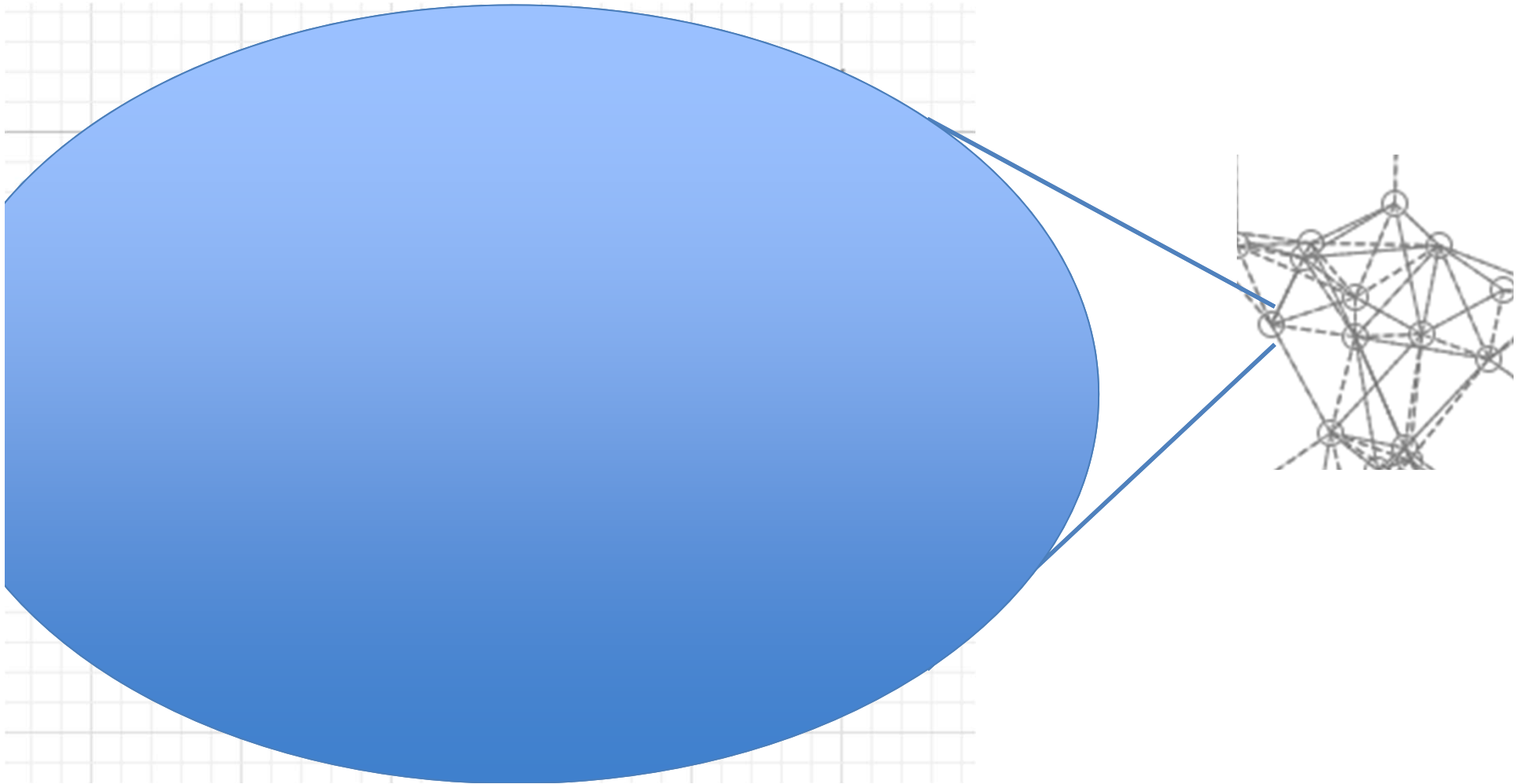

Advantages of AnyLogic

(as compared to other Agent-Based Modeling Software)

- Primarily declarative specification
- Less code
- Great flexibility
- Access to Java libraries
- Support for multiple modeling types
- Support for mixture of modeling types

Painful Sides of AnyLogic Education/Advanced

- Export of model results: Lack of trajectory files
- Lack of debugger
- Need for bits of Java code
- Many pieces of system